



Introduction:

This document covers typical wiring for the 24VDC and Multi Volt contact blocks. Please note that the wiring shown in this paper are just examples and it can vary from job to job based on Controller specifications. It is the responsibility of the person wiring the contact block to verify that the specific wiring requirements of the controller are met. If you have any questions, please contact MAD Customer Service at customerservice@madelevator.com or (416) 245-8500 or 1-866-967-8500

The contact blocks shown in the examples are two contacts though wiring shown is only using one contact. In some instances two contacts are required and wiring for the second contact depends on the Controller's requirements. In the event the customer requires technical support, all technical inquiries can be directed to MAD's Customer Service.

CAR CALLS	WIRE COLOR
+24V"	Red
"-24V"	Blue
Jumper for Car Call	Black
Car call Signal	Black
Door Open	Black
Door Close	Black
Alarm	Black

FIRE SERVICE CABINET	
Door Open	Orange
Door Close	Orange
Car Cancel	Orange
Fire Service Light Indicator "+"	Red
Fire Service Light Indicator "-"	Orange

CALL PUSHBUTTONS

24V DC Push Button

Typical wiring for Negative Common:

- -24V is connected to the “C1” screw terminal on the contact block
- +24V is connected to “+” screw terminal on the contact block
- “-” and “NO1” screw terminals on the contact block are jumpered together
- The wire from “NO1” screw terminal is terminated to the terminal block for a CALL signal

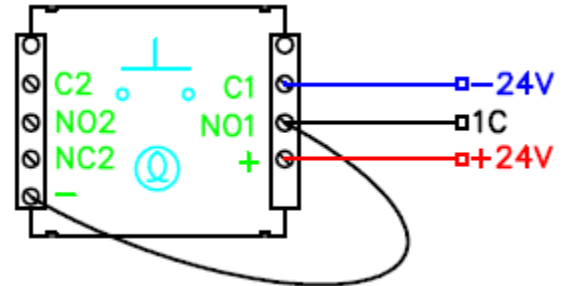

Typical wiring for Positive Common:

- -24V is connected to the “-” screw terminal on the contact block
- +24V is connected to “C1” screw terminal on the contact block
- “+” and “NO1” screw terminals on the contact block are jumpered together
- The wire from “NO1” screw terminal is terminated to the terminal block for a CALL signal

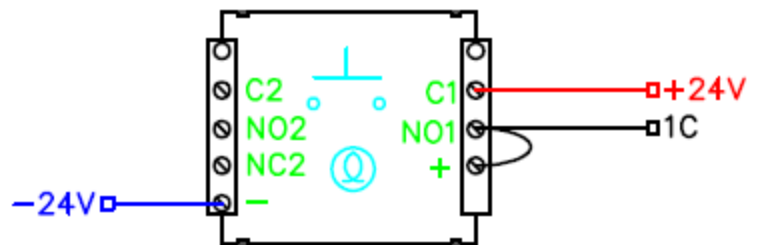

Note: When wiring more than one contact block, the +24V/-24V and COM can be jumper contact block to contact block



Multi volt Push Button

Multi Volt pushbuttons can be wired for 24/120 DC/AC or 6V DC.

For 24/120 DC/AC

Typical wiring for Positive Common

- -24/120V is connected to the “24/120” screw terminal on the contact block
- +24/120V is connected to “C1” screw terminal on the contact block
- “+24/120” and “NO1” screw terminals on the contact block are jumpered together
- The wire from “NO1” screw terminal on the contact block is terminated to the terminal block for a CALL signal

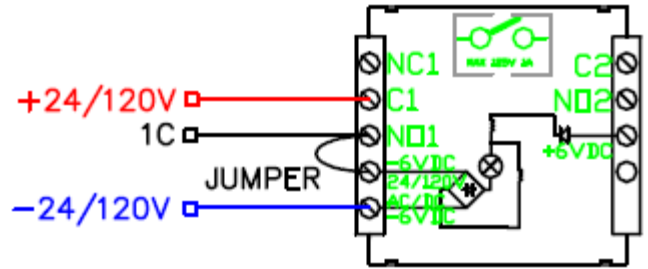

Typical wiring for Negative Common

- -24/120V is connected to the “C1” screw terminal on the contact block
- +24/120V is connected to “+24/120” screw terminal on the contact block
- “-24/120” and “NO1” screw terminals on the contact block are jumpered together.
- The wire from “NO1” screw terminal is terminated to the terminal block for a CALL signal

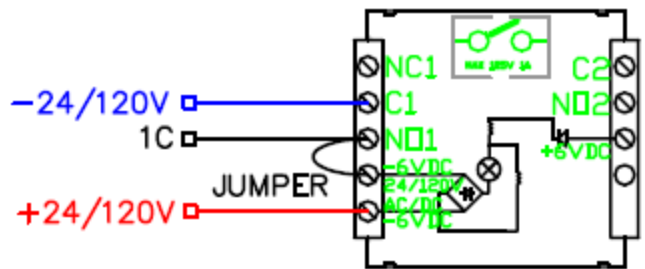

Note: when wiring for 24/120 DC/AC, any one of the two screw terminals with 24/120 DC /AC on the contact block can be selected as +24/120 DC/AC and the other one to be -24/120 DC/AC

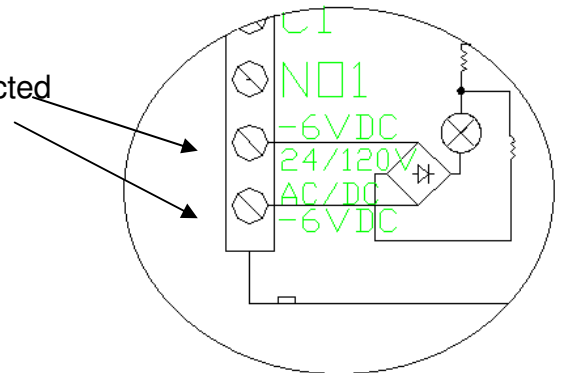



Multi volt Push Button
For 6V DC

Typical wiring for Negative Common

- -6V is connected to “C1” screw terminal on the contact block
- +6V is connected to “+6V” screw terminal on the contact block
- “-6V” and “NO1” screw terminals on the contact block are jumper together
- The wire from “NO1” screw terminal is terminated to the terminal block for a CALL signal

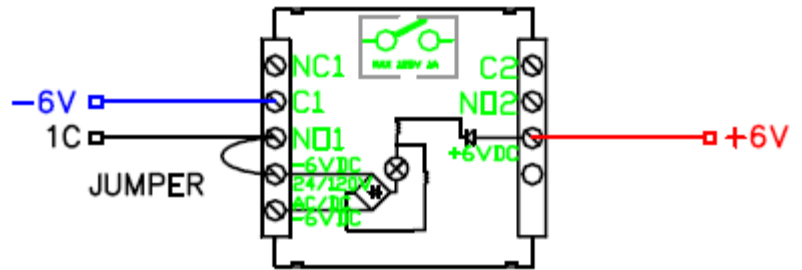

Typical wiring for Positive Common

- +6V is connected to “C1” screw terminal on the contact block
- -6V is connected to “-6V” screw terminal on the contact block
- “+6V” and “NO1” screw terminals on the contact block are jumper together
- The wire from “NO1” screw terminal is terminated to the terminal block for a CALL signal

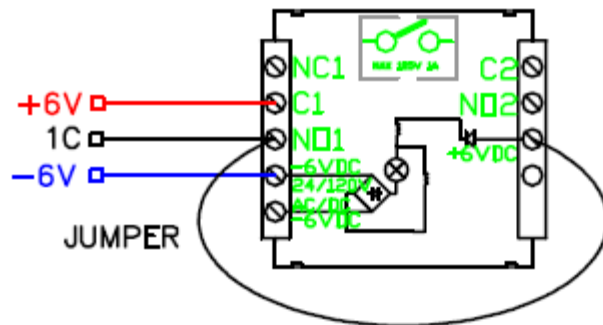

Note: when wiring for 6VDC, any of the two “-6V DC” screw terminals on the contact block can be selected



Alarm

When only contact is required

- AL1 is connected to “C1” screw terminal on the contact block
- AL2 is connected to “NO1” screw terminal on the contact block

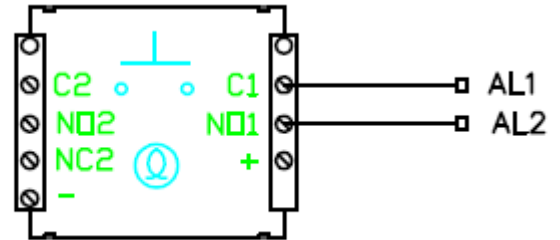

When illumination is required

Typical wiring for Positive Common:

- AL1 is connected to “C1” screw terminal on the contact block
- AL2 is connected to “NO1” screw terminal on the contact block
- “NO1” and “+” screw terminals on the contact block are jumper together
- AL3 is connected to “-” screw terminal on the contact block

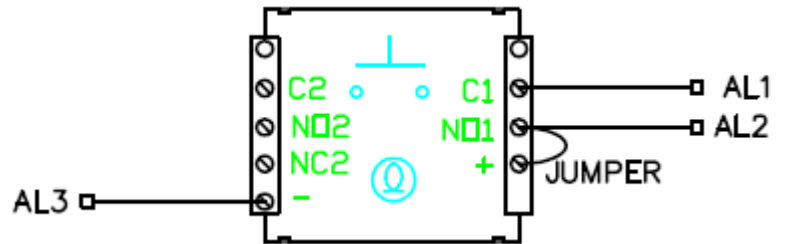

Negative Common:

- AL1 is connected to “C1” screw terminal on the contact block
- AL2 is connected to “NO1” screw terminal lock
- “NO1” and “-” screw terminals on the contact block are jumper together
- AL3 is connected to “+” screw terminal on the contact block

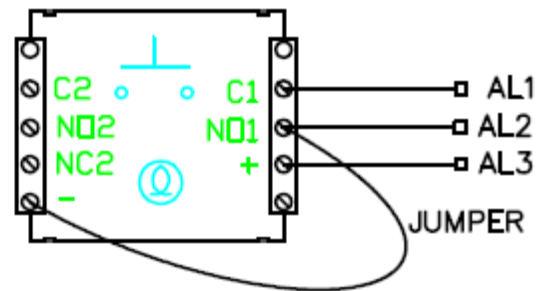



FIRE SERVICE CABINET

Fire Service Light Indicator

Fire Service Light Indicator is usually wired in three different ways depending on Controller specification:

1.

- FSL1 is connected to the “+” screw terminal on the contact block
- FSL2 is connected to “-” screw terminal on the contact block

2.

- FSL1 is connected to the “+” screw terminal on the contact block
- +24V is connected to “-” screw terminal on the contact block

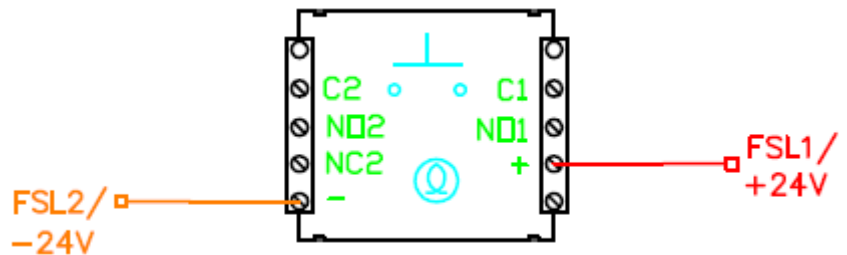

3.

- FSL1 is connected to the “+” screw terminal on the contact block
- -24V is connected to “-” screw terminal on the contact block



Door Open/ Door Close

Door Open/ Door Close are usually wired in three different ways:

- 1.**
 - DO1/DC1 is connected to the “C1” screw terminal on the contact block
 - DO2/DC2 is connected to “NO1” screw terminal on the contact block
- 2.**
 - DO1/DC1 is connected to the “C1” screw terminal on the contact block
 - +24V is connected to “NO1” screw terminal on the contact block
- 3.**
 - DO1/DC1 is connected to the “C1” screw terminal on the contact block
 - -24V is connected to “NO1” screw terminal on the contact block

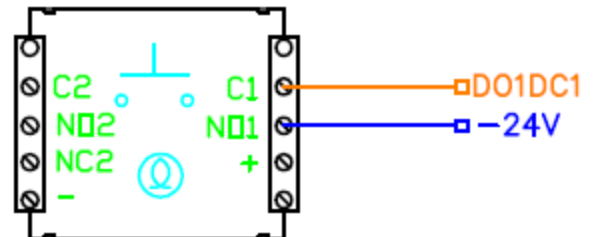
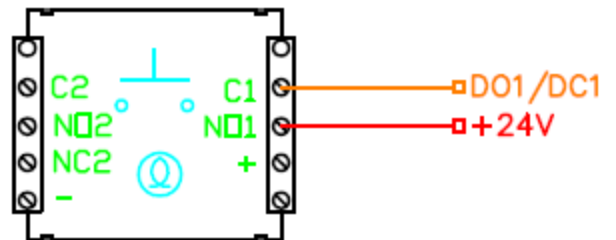
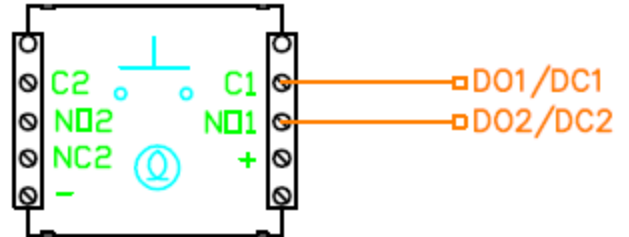

Note: If LED is required e.g. for case 3 then “C1” on the contact block will needed to be jumper to “-“on the contact block and +24V will be required to connect to “+” on the contact block



Car Cancel

Car Cancel is usually wired in three different ways:

1.

- CC1 is connected to the “C1” screw terminal on the contact block
- CC2 is connected to “NO1” screw terminal on the contact block

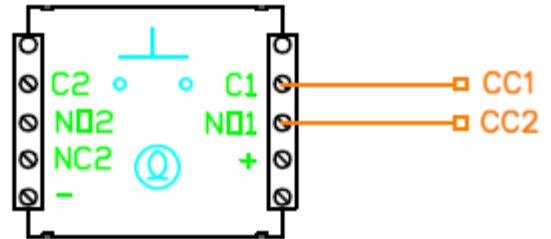

2.

- CC1 is connected to the “C1” screw terminal on the contact block
- +24V is connected to “NO1” screw terminal on the contact block

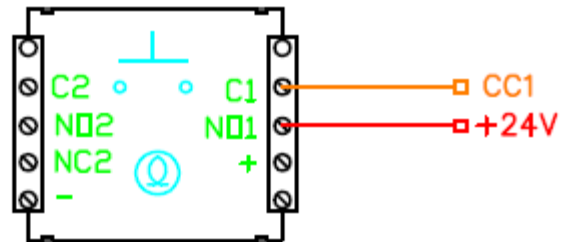

3.

- CC1 is connected to the “C1” screw terminal on the contact block
- -24V is connected to “NO1” screw terminal on the contact block

